

TEST REPORT

of

R&TTE (1999/5/EC) Directive

ETSI EN 300 328 V1.8.1: 2012

Product: BT 4.0 Low Energy Single Mode Module

Brand: BlueRadios

Model: BR-LE4.0-S2A

Model Difference: N/A

Applicant: BlueRadios, Inc.

Address: 7173 S. Hanava Street, Suite 600, Englewood,
CO/USA

Test Performed by:

International Standards Laboratory

<Lung-Tan LAB>

*Address:

No. 120, Lane 180, San Ho Tsuen, Hsin Ho Rd.

Lung-Tan Hsiang, Tao Yuan County 325, Taiwan

*Tel : 886-3-407-1718; Fax: 886-3-407-1738

Report No.: **ISL-14LR207E328**

Issue Date : **2014/09/09**



Test results given in this report apply only to the specific sample(s) tested and are traceable to national or international standard through calibration of the equipment and evaluating measurement uncertainty herein.

This report MUST not be used to claim product endorsement by TAF, NEMKO or any agency of the Government.



This test report shall not be reproduced except in full, without the written approval of International Standards Laboratory.

VERIFICATION OF COMPLIANCE

Applicant: BlueRadios, Inc.
Equipment Under Test: BT 4.0 Low Energy Single Mode Module
Brand Name: BlueRadios
Model Number: BR-LE4.0-S2A
Model Different: N/A
Date of Test: 2014/08/30 ~ 2014/09/05
Date of EUT Received: 2014/08/30

APPLICABLE STANDARDS	
STANDARD	TEST RESULT
ETSI EN 300 328 v1.8.1:2012	Complied

The above equipment was tested by International Standards Laboratory for compliance with the requirements set forth in the European Standard ETSI EN 300 328 v1.8.1:2012. class I device under R&TTE Directive 1999/5/EC. The results of testing in this report apply to the product/system that was tested only. Other similar equipment will not necessarily produce the same results due to production tolerance and measurement uncertainties.

Test By:	 <hr style="width: 80%; margin: auto;"/> Dino Chen / Engineer	Date:	2014/09/09
Prepared By:	 <hr style="width: 80%; margin: auto;"/> Elisa Chen / Specialist	Date:	2014/09/09
Approved By:	 <hr style="width: 80%; margin: auto;"/> Vincent Su / Technical Manager	Date:	2014/09/09

Version

Version No.	Date	Description
00	2014/09/09	Initial creation of document

TABLE OF CONTENTS

1. DESCRIPTION OF EQUIPMENT UNDER TEST (EUT)	5
2. GENERAL DESCRIPTION OF APPLIED STANDARDS	6
3. TEST FACILITY	6
4. BLOCK DIAGRAM OF TEST SETUP	7
5. FREQUENCY HOPPING EQUIPMENT MEASUREMENT (FHSS)	12
6. OTHER TYPES OF WIDE BAND MODULATION EQUIPMENT	24
APPENDIX A PHOTOGRAPHS OF SET UP	41
APPENDIX B PHOTOGRAPHS OF EUT	44

1. DESCRIPTION OF EQUIPMENT UNDER TEST (EUT)

General:

Product Name:	BT 4.0 Low Energy Single Mode Module
Brand Name:	BlueRadios
Model Name:	BR-LE4.0-S2A
Model Difference:	N/A
Power Supply:	5Vdc from USB of host
Type of Equipment:	Plug-in equipment
Temperature Range:	-20°C to 55 °C
Simultaneous transmissions:	No
Hardware Version:	N/A
Software Version:	N/A

Bluetooth:

Frequency Range:	2402 – 2480MHz
Bluetooth Version:	V4.0
Channel number:	40 channels, 2MHz step
Modulation type:	GFSK
Transmit Power: EIRP:	4.70 dBm
Occupied Channel Bandwidth:	Within 2400-2483.5MHz
Duty Cycle:	N/A
Adaptive/ Non-Adaptive:	Adaptive
LBT (Listen Before Talk):	Yes
	<input checked="" type="checkbox"/> Adaptive Frequency Hopping using LBT based DAA <input type="checkbox"/> Adaptive Frequency Hopping using other forms of DAA (non-LBT based) <input type="checkbox"/> Short Control Signaling Transmissions
Antenna Beamforming:	No
Antenna Designation:	Chip Antenna: 2dBi

The EUT is compliance with Bluetooth BLE Standard.

Remark: The above DUT's information was declared by manufacturer. Please refer to the specifications or user's manual for more detailed description.

1.1. DESCRIPTION OF TEST MODES

The EUT has been tested under Operating condition. To control the EUT for staying in continuous transmitting and receiving mode is programmed.

BT LE mode: Channel low (2402MHz), mid (2442MHz) and high (2480MHz) are chosen for testing.

Normal test conditions :

Temperature : -20°C to 55 °C

Relative humidity: 20 % to 75 %

Normal Voltage: 5.0Vdc

Extreme temperatures and Power source voltage

Refer to section 5.1.1.2 of EN 300328

For tests at extreme temperatures, measurements shall be made over the extremes of the operating temperature ranges as declared by the manufacturer.

For tests at extreme voltage, measurements shall be made over the extremes of the power source voltage range as declared by the manufacturer.

2. GENERAL DESCRIPTION OF APPLIED STANDARDS

The EUT According to the Specifications, it must comply with the requirements of the following standards:

ETSI EN 300 328 V1.8.1 : 2012– Electromagnetic compatibility and Radio spectrum Matters (ERM) ; Wideband transmission systems; Data transmission equipment operating in the 2.4GHz ISM band and using wide band modulation techniques:

3. TEST FACILITY

International Standards Laboratory

<Lung-Tan LAB>

No. 120, Lane 180, San Ho Tsuen, Hsin Ho Rd., Lung-Tan Hsiang, Tao Yuan County 325, Taiwan

A fully anechoic chamber was used for the radiated spurious emissions test.

TAF Accreditation Lab. Lab number: 0997

NEMKO Laboratory Authorities No.: ELA 113B

4. BLOCK DIAGRAM OF TEST SETUP

4.1. EUT Configuration

Fig. 4-1 Configuration of Tested System

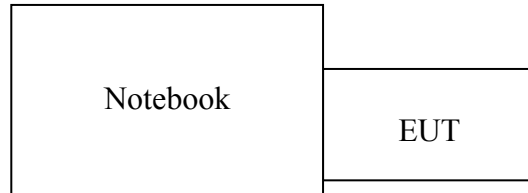
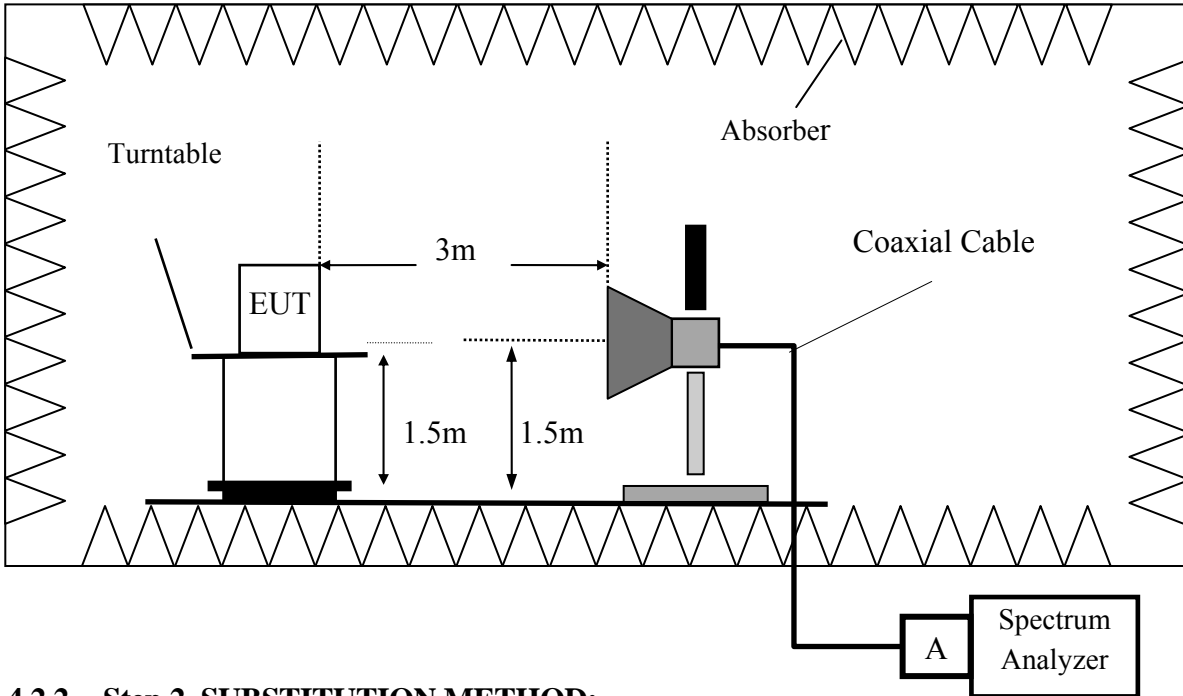

Table 4-1 Equipment Used in Tested System

Item	Equipment	Mfr./Brand	Model name	Series No	Data Cable	Power Cable
1	Notebook	Lenovo	X220	N/A	Shield	Non-shield

4.2. Test Setup for ERP/EIRP Measurement

4.2.1. Step 1. Field Strength Measurement



4.2.2. Step 2. SUBSTITUTION METHOD:

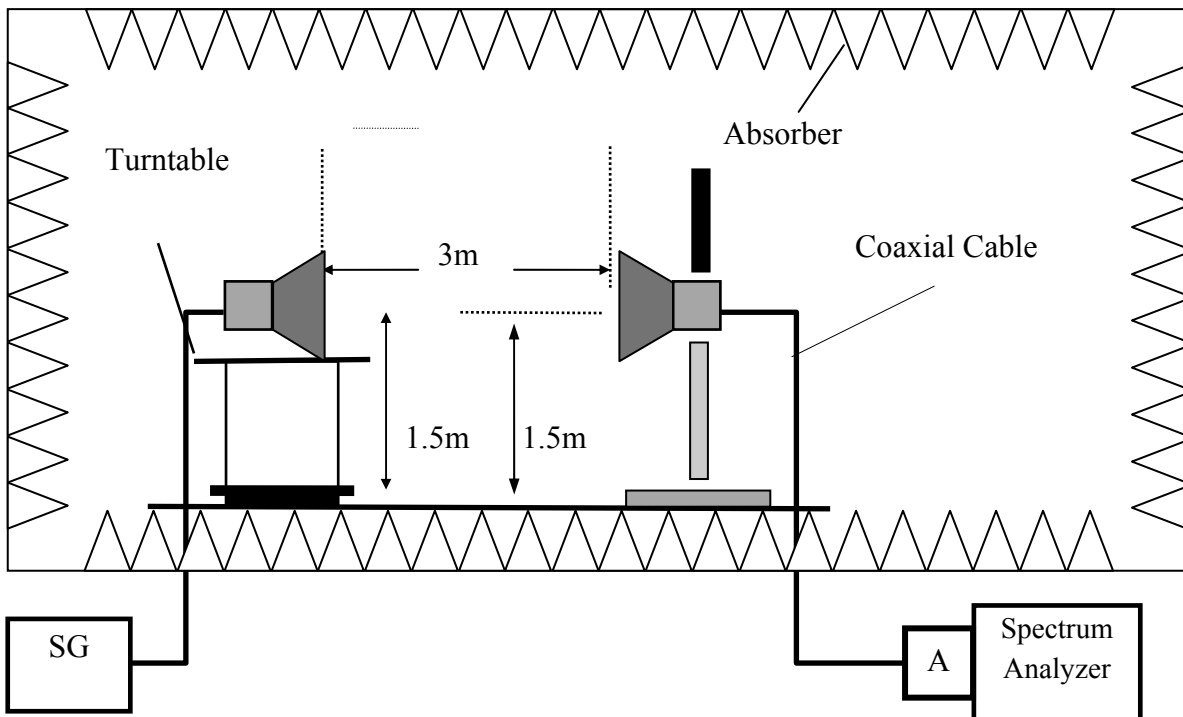

4.3. Test Setup for Conducted Measurement

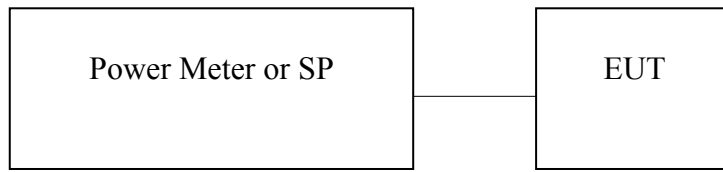

4.4. Test Setup for Extreme test

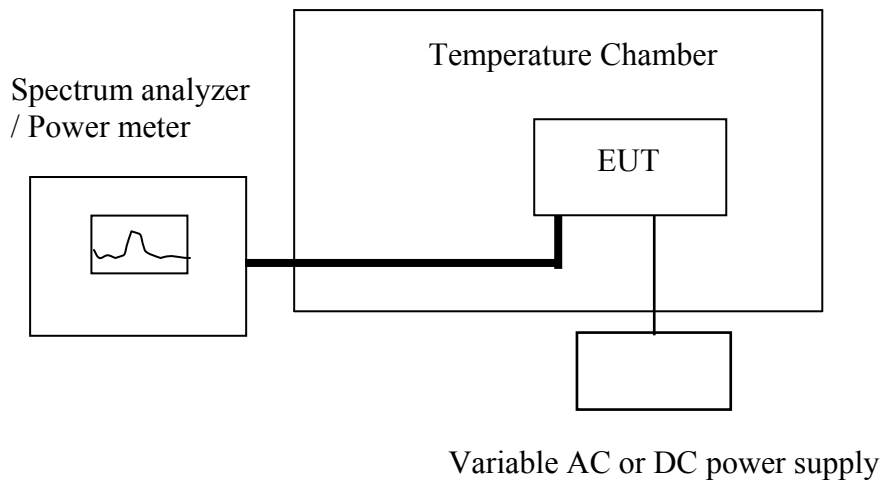

4.5. Test Setup for verifying the adaptivity/receiver blocking of an equipment

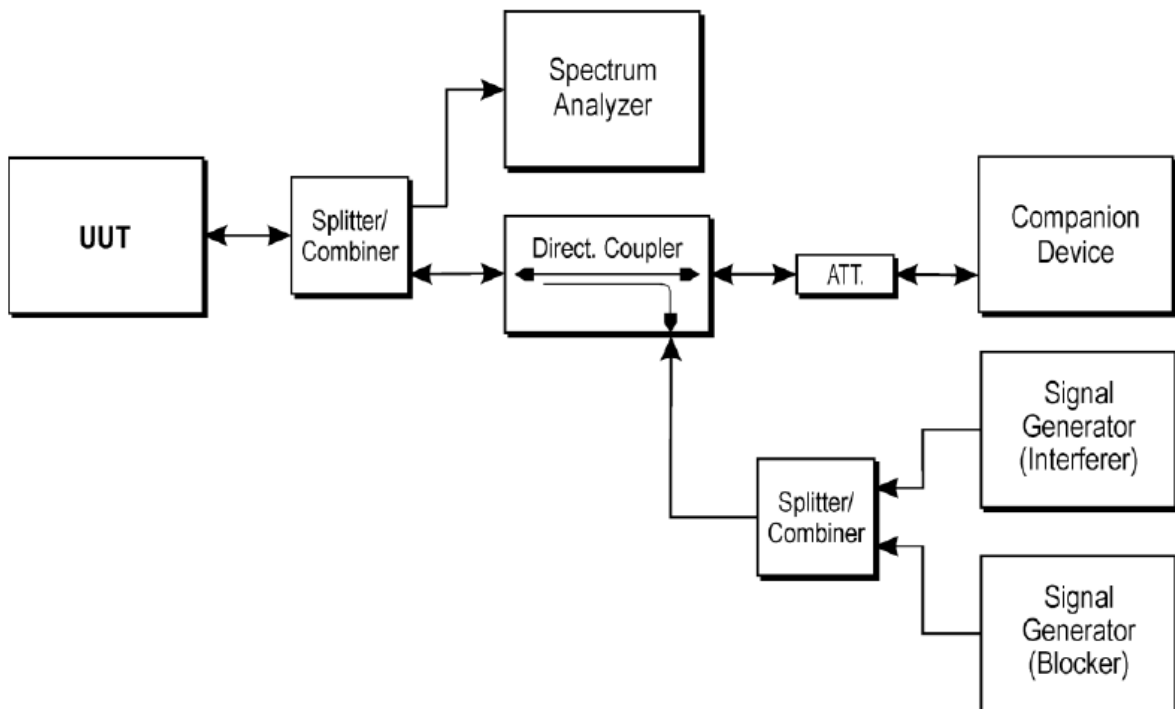

4.6. Measurement Equipment Used:

Chamber (1166)					
EQUIPMENT TYPE	MFR	MODEL NUMBER	SERIAL NUMBER	LAST CAL.	CAL DUE.
Spectrum Analyzer 21(26.5GHz)	Agilent	N9010A	MY52100117	05/08/2014	05/07/2015
Dipole antenna	SCHWARZBECK	VHAP,30-300	919	12/03/2013	12/02/2015
Dipole antenna	SCHWARZBECK	UHAP,300-1000	1195	12/03/2013	12/02/2015
Loop Antenna	A.H.SYSTEM	SAS-564	294	03/07/2013	03/06/2015
Bilog Antenna	Schaffner	9168	9168-495	06/19/2014	06/18/2015
Horn antenna1-18G	EM	EM-AH-10180	2011071401	09/05/2014	09/04/2015
Horn antenna18-26G	Com-power	AH-826	081001	05/15/2013	05/14/2015
Horn antenna26-40G	Com-power	AH-640	100A	01/09/2013	01/08/2015
Preamplifier9-1.3G	HP	8447F	NA	08/28/2014	08/27/2015
Preamplifier1-26G	EM	EM01M26G	NA	02/20/2014	02/19/2015
Preamplifier26-40G	MITEQ	JS-26004000-27-5A	818471	05/08/2013	05/07/2015
Cable	HUBER SUHNER	SUCOFLEX104A	1166 cable 001	02/19/2014	02/18/2015
Cable	HUBER SUHNER	SUCOFLEX104A	1166 cable 002	02/21/2014	02/20/2015
SUCOFLEX 1GHz~40GHz cable	HUBER SUHNER	Sucoflex 102	27963/2&37421/2	10/03/2013	10/02/2015
Signal Generator	R&S	SMU200A	102330	02/19/2014	02/18/2015
Signal Generator	Anritsu	MG3692A	20311	10/30/2013	10/29/2014
2.4G Filter	Micro-Tronics	Brm50702	76	12/27/2013	12/26/2014

Conducted Emission Test Site					
EQUIPMENT TYPE	MFR	MODEL NUMBER	SERIAL NUMBER	LAST CAL.	CAL DUE.
Power Meter 05	Anritsu	ML2495A	1116010	05/08/2014	05/07/2015
Power Sensor 05	Anritsu	MA2411B	34NKF50	05/08/2014	05/07/2015
Temperature Chamber	KSON	THS-B4H100	2287	03/17/2014	03/16/2015
DC Power supply	ABM	51850	N/A	08/16/2014	08/15/2015
AC Power supply	EXTECH	CFC105W	NA	12/19/2013	12/18/2014
Attenuator	Woken	Watt-65m3502	11051601	NA	NA
Splitter	MCLI	PS4-199	12465	12/27/2013	12/26/2014
Spectrum analyzer	Agilent	N9030A	MY51360021	05/02/2014	05/01/2015

Adaptive/ Receiver Blocking Test Site					
EQUIPMENT TYPE	MFR	MODEL NUMBER	SERIAL NUMBER	LAST CAL.	CAL DUE.
Signal Generator	Agilent	E4438C	MY49071550	04/29/2014	04/28/2015
Spectrum analyzer	Agilent	N9030A	MY51360021	05/02/2014	05/01/2015
AP Router	Cisco	AIR-RM1252A G-A-K9	FTX1220905D	NA	NA
Direction Coupler	Krytar	1821S	1461	NA	NA
Splitter	Mini-Circuits	ZN2PD-63-S	UU97201111	NA	NA
Attenuator	Woken	Watt-65m3502	11051601	NA	NA
Software	Agilent	DFS TEST	NA	NA	NA
Software	Agilent	Adaptive TEST	NA	NA	NA
Cable	Draka	NA	NA	NA	NA

5. Frequency Hopping Equipment Measurement (FHSS)

5.1. ETSI EN 300 328 SUB-CLAUSE 4.3.1.1 RF Output Power

This requirement applies to all types of Frequency Hopping equipment

5.1.1. Limit:

The maximum RF output power for adaptive Frequency Hopping equipment shall be equal to or less than 20 dBm.

The maximum RF output power for non-adaptive Frequency Hopping equipment, shall be declared by the supplier. The maximum RF output power for this equipment shall be equal to or less than the value declared by the supplier. This declared value shall be equal to or less than 20 dBm.

This limit shall apply for any combination of power level and intended antenna assembly.

5.1.2. Test Procedure:

See Sub-Clause 5.3.2.1 of ETSI EN 300 328 for the test conditions

See Sub-Clause 5.3.2.2.1.1 of ETSI EN 300 328 for conducted method.

5.1.3. Test Result:

N/A, this is an equipment using wide band modulation other than FHSS.

5.2. ETSI EN 300 328 SUB-CLAUSE 4.3.1.2 Duty Cycle, Tx-sequence, Tx-gap

These requirements apply to non-adaptive frequency hopping equipment or to adaptive frequency hopping equipment operating in a non-adaptive mode.

These requirements do not apply for equipment with a maximum declared RF Output power of less than 10 dBm e.i.r.p. or for equipment when operating in a mode where the RF Output power is less than 10 dBm e.i.r.p. Medical devices requiring reverse compatibility with other medical devices placed on the market when earlier versions of the present document were harmonised, are allowed to have an operating mode in which they do not have to comply with the requirements for Duty Cycle, Tx-sequence and Tx-gap.

5.2.1. Limit:

For non-adaptive FHSS equipment, the Duty Cycle shall be equal to or less than the maximum value declared by the supplier. In addition, the maximum Tx-sequence time shall be 5 ms while the minimum Tx-gap time shall be 5 ms.

5.2.2. Test Procedure:

See Sub-Clause 5.3.2.1 of ETSI EN 300 328 for the test conditions

See Sub-Clause 5.3.2.2.1.2 of ETSI EN 300 328 for conducted method.

5.2.3. Test Result:

N/A, this is an equipment using wide band modulation other than FHSS.

5.3. ETSI EN 300 328 SUB-CLAUSE 4.3.1.3 Dwell Time, Minimum Frequency Occupation and Hopping Sequence

These requirements apply to all types of frequency hopping equipment

5.3.1. Limit:

Non-adaptive frequency hopping systems

The accumulated Dwell Time on any hopping frequency shall not be greater than 15 ms within any period of 15 ms multiplied by the minimum number of hopping frequencies (N) that have to be used. Non-adaptive medical devices requiring reverse compatibility with other medical devices placed on the market when earlier versions of the present document were harmonised, are allowed to have an operating mode in which the maximum dwell time is 400 ms.

The hopping sequence(s) shall contain at least N hopping frequencies where N is 15 or 15 divided by the minimum Hopping Frequency Separation in MHz, whichever is the greater.

The Minimum Frequency Occupation Time shall be equal to one dwell time within a period not exceeding four times the product of the dwell time per hop and the number of hopping frequencies in use.

Adaptive frequency hopping systems

Adaptive Frequency Hopping systems shall be capable of operating over a minimum of 70 % of the band specified in clause 1.

The maximum accumulated dwell time on any hopping frequency shall be 400 ms within any period of 400 ms multiplied by the minimum number of hopping frequencies (N) that have to be used.

The hopping sequence(s) shall contain at least N hopping frequencies at all times, where N is 15 or 15 divided by the minimum Hopping Frequency Separation in MHz, whichever is the greater.

The Minimum Frequency Occupation Time shall be equal to one dwell time within a period not exceeding four times the product of the dwell time per hop and the number of hopping frequencies in use.

Other Requirements

Frequency Hopping equipment shall transmit on a minimum of two hopping frequencies.

For non-Adaptive Frequency Hopping equipment, when not transmitting on a hopping frequency, the equipment has to occupy that frequency for the duration of the typical dwell time.

For Adaptive Frequency Hopping systems using LBT based DAA, if a signal is detected during the CCA, these systems may jump immediately to the next frequency in the hopping sequence (see clause 4.3.1.6.1.2 point 2) provided the limit for maximum dwell is respected.

5.3.2. Test Procedure:

See Sub-Clause 5.3.4.1 of ETSI EN 300 328 for the test conditions

See Sub-Clause 5.3.4.2.1 of ETSI EN 300 328 for conducted method.

5.3.3. Test Result:

N/A, this is an equipment using wide band modulation other than FHSS.

5.4. ETSI EN 300 328 SUB-CLAUSE 4.3.1.4 Hopping Frequency Separation

This requirement applies to all types of frequency hopping equipment.

5.4.1. Limit:

Non-adaptive frequency hopping systems

The minimum Hopping Frequency Separation shall be equal to Occupied Channel Bandwidth (see clause 4.3.1.7) of a single hop, with a minimum separation of 100 kHz.

Adaptive frequency hopping systems

The minimum Hopping Frequency Separation shall be 100 kHz.

5.4.2. Test Procedure:

See Sub-Clause 5.3.5.1 of ETSI EN 300 328 for the test conditions

See Sub-Clause 5.3.5.2.1 of ETSI EN 300 328 for conducted method.

5.4.3. Test Result:

N/A, this is an equipment using wide band modulation other than FHSS.

5.5. ETSI EN 300 328 SUB-CLAUSE 4.3.1.5 Medium Utilisation (MU) factor

This requirement does not apply to adaptive equipment unless operating in a non-adaptive mode.

In addition, this requirement does not apply for equipment with a maximum declared RF Output power level of less than 10 dBm e.i.r.p. or for equipment when operating in a mode where the RF Output power is less than 10 dBm e.i.r.p.

Medical devices requiring reverse compatibility with other medical devices placed on the market when earlier versions of the present document were harmonised, are allowed to have an operating mode in which they have a Medium Utilisation above the limit defined in clause 4.3.1.5.2.

5.5.1. Limit:

The maximum Medium Utilisation factor for non-adaptive Frequency Hopping equipment shall be 10 %. The Medium Utilisation (MU) factor is a measure to quantify the amount of resources (Power and Time) used by non-adaptive equipment. The Medium Utilisation factor is defined by the formula:

$MU = (P/100 \text{ mW}) \times DC$, where: MU is Medium Utilisation factor in %.

P is the RF output power as defined in clause 4.3.1.1.1 expressed in mW.

DC is the Duty Cycle as defined in clause 4.3.1.2.1 expressed in %.

5.5.2. Test Procedure:

See Sub-Clause 5.3.2.1 of ETSI EN 300 328 for the test conditions

See Sub-Clause 5.3.2.2.1.3 of ETSI EN 300 328 for conducted method.

5.5.3. Test Result:

N/A, this is an equipment using wide band modulation other than FHSS.

5.6. ETSI EN 300 328 SUB-CLAUSE 4.3.1.6 Adaptivity (Adaptive Frequency Hopping)

This requirement does not apply to non-adaptive equipment or adaptive equipment operating in a non-adaptive mode providing the equipment complies with the requirements and/or restrictions applicable to non-adaptive equipment.

In addition, this requirement does not apply for equipment with a maximum declared RF Output power level of less than 10 dBm e.i.r.p. or for equipment when operating in a mode where the RF Output power is less than 10 dBm e.i.r.p.

Adaptive Frequency Hopping equipment is allowed to operate in a non-adaptive mode providing it complies with the requirements applicable to non-adaptive frequency hopping equipment. Adaptive Frequency Hopping equipment is allowed to have Short Control Signalling Transmissions (e.g. ACK/NACK signals, etc.) without sensing the frequency for the presence of other signals. See clause 4.3.1.6.3.

Adaptive Frequency Hopping (AFH) equipment uses a Detect And Avoid (DAA) mechanism which allows an equipment to adapt to its environment by identifying frequencies that are being used by other equipment. Adaptive Frequency Hopping systems shall implement either of the DAA mechanisms provided in clauses 4.3.1.6.1 or 4.3.1.6.2.

NOTE: Adaptive systems are allowed to switch dynamically between different adaptive modes.

5.6.1. Limit:

ETSI EN 300 328 SUB-CLAUSE 4.3.1.6.1 Adaptive Frequency Hopping using LBT based DAA

The CCA observation time shall be not less than 0,2 % of the Channel Occupancy Time with a minimum of 20 μ s.

The Channel Occupancy Time for a given hopping frequency, which starts immediately after a successful CCA, shall be less than 60 ms followed by an Idle Period of minimum 5 % of the Channel Occupancy Time with a minimum of 100 μ s.

ETSI EN 300 328 SUB-CLAUSE 4.3.1.6.2 Adaptive Frequency Hopping using other forms of DAA (non-LBT based)

The Channel Occupancy Time for a given hopping frequency shall be less than 40 ms. For equipment using a dwell time > 40 ms that want to have other transmissions during the same hop (dwell time) an Idle Period (no transmissions) of minimum 5 % of the Channel Occupancy Period with a minimum of 100 μ s shall be implemented. After this, the procedure as in step 1 need to be repeated before having new transmissions on this hopping frequency during the same dwell time.

ETSI EN 300 328 SUB-CLAUSE 4.3.1.6.3 Short Control Signalling Transmissions

Adaptive equipment may or may not have Short Control Signalling Transmissions

If implemented, Short Control Signalling Transmissions shall have a maximum duty cycle of 10 % within an observation period of 50 ms or within an observation period equal to the dwell time, whichever is the shorter.

5.6.2. Test Procedure:

See Sub-Clause 5.3.7.1 of ETSI EN 300 328 for the test conditions

See Sub-Clause 5.3.7.2.1 of ETSI EN 300 328 for conducted method.

5.6.3. Test Result:

N/A, this is an equipment using wide band modulation other than FHSS.

5.7. ETSI EN 300 328 SUB-CLAUSE 4.3.1.7 Occupied Channel Bandwidth

This requirement applies to all types of frequency hopping equipment

5.7.1. Limit:

The Occupied Channel Bandwidth for each hopping frequency shall fall completely within the band given in clause 1.

For non-adaptive Frequency Hopping equipment with e.i.r.p greater than 10 dBm, the Occupied Channel Bandwidth for every occupied hopping frequency shall be equal to or less than the value declared by the supplier. This declared value shall not be greater than 5 MHz.

5.7.2. Test Procedure:

See Sub-Clause 5.3.8.1 of ETSI EN 300 328 for the test conditions

See Sub-Clause 5.3.8.2.1 of ETSI EN 300 328 for conducted method.

5.7.3. Test Result:

N/A, this is an equipment using wide band modulation other than FHSS.

5.8. ETSI EN 300 328 SUB-CLAUSE 4.3.1.8 Transmitter Unwanted Emissions in the out-of-band Domain

This requirement applies to all types of frequency hopping equipment

5.8.1. Limit:

The transmitter unwanted emissions in the out-of-band domain but outside the allocated band, shall not exceed the values provided by the mask in figure 1.

NOTE: Within the 2 400 MHz to 2 483,5 MHz band, the Out-of-band emissions are fulfilled by compliance with the Occupied Channel Bandwidth requirement in clause 4.3.1.7.

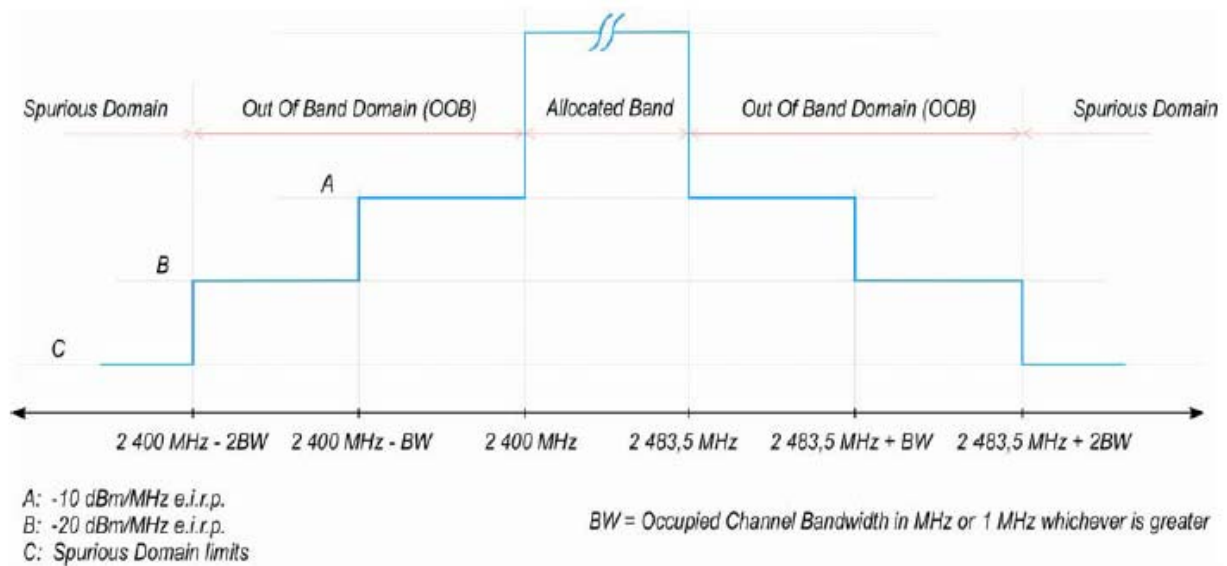

Transmit mask

5.8.2. Test Procedure:

Conducted test method

See Sub-Clause 5.3.9.1 of ETSI EN 300 328 for the test conditions

See Sub-Clause 5.3.9.2.1 of ETSI EN 300 328 for conducted method.

5.8.3. Test Result:

N/A, this is an equipment using wide band modulation other than FHSS.

5.9. ETSI EN 300 328 SUB-CLAUSE 4.3.1.9 Transmitter Unwanted Emissions in the Spurious Domain

This requirement applies to all types of frequency hopping equipment.

5.9.1. Limit:

The transmitter unwanted emissions in the spurious domain shall not exceed the values given in table

Transmitter limits for Narrowband Spurious emissions

Frequency Range	Maximum power, e.r.p. (≤ 1 GHz) e.i.r.p. (> 1 GHz)	Bandwidth
30 MHz to 47 MHz	-36 dBm	100 kHz
47 MHz to 74 MHz	-54 dBm	100 kHz
74 MHz to 87,5 MHz	-36 dBm	100 kHz
87,5 MHz to 118 MHz	-54 dBm	100 kHz
118 MHz to 174 MHz	-36 dBm	100 kHz
174 MHz to 230 MHz	-54 dBm	100 kHz
230 MHz to 470 MHz	-36 dBm	100 kHz
470 MHz to 862 MHz	-54 dBm	100 kHz
862 MHz to 1 GHz	-36 dBm	100 kHz
1 GHz to 12,75 GHz	-30 dBm	1 MHz

5.9.2. Test Procedure:

See Sub-Clause 5.3.10.1 of ETSI EN 300 328 for the test conditions

See Sub-Clause 5.3.10.2.1 and 5.3.10.2.2 of ETSI EN 300 328 for Conducted Pre-Scan test method.

See Sub-Clause 5.3.10.2.2 of ETSI EN 300 328 for final Radiated test method.

5.9.3. Test Result:

N/A, this is an equipment using wide band modulation other than FHSS.

5.10. ETSI EN 300 328 SUB-CLAUSE 4.3.1.10 Receiver Spurious Emissions

This requirement applies to all types of frequency hopping equipment.

5.10.1. Limit:

The spurious emissions of the receiver shall not exceed the values given in table.

Spurious emission limits for receivers

Frequency Range	Maximum power, e.r.p. (\leq 1 GHz) e.i.r.p. ($>$ 1 GHz)	Measurement Bandwidth
30 MHz to 1 GHz	-57 dBm	100 kHz
1 GHz to 12,75 GHz	-47 dBm	1 MHz

5.10.2. Test Procedure:

See Sub-Clause 5.3.11.1 of ETSI EN 300 328 for the test conditions

See Sub-Clause 5.3.11.2.1 and 5.3.11.2.2 of ETSI EN 300 328 for Conducted Pre-Scan test method.

See Sub-Clause 5.3.11.2.2 of ETSI EN 300 328 for final Radiated test method.

5.10.3. Test Result

N/A, this is an equipment using wide band modulation other than FHSS.

5.11. ETSI EN 300 328 SUB-CLAUSE 4.3.1.11 Receiver Blocking

This requirement does not apply to non-adaptive equipment or adaptive equipment operating in a non-adaptive mode.

In addition, this requirement does not apply for equipment with a maximum declared RF Output power level of less than 10 dBm e.i.r.p. or for equipment when operating in a mode where the RF Output power is less than 10 dBm e.i.r.p.

5.11.1. Limit:

Adaptive Frequency Hopping equipment shall comply with the requirements defined in clauses 4.3.1.6.1 (LBT based DAA) or 4.3.1.6.2 (non-LBT based DAA) in the presence of a blocking signal with characteristics as provided in table 3.

Table 3: Receiver Blocking parameters

Equipment Type (LBT / non- LBT)	Wanted signal mean power from companion device	Blocking signal frequency [MHz]	Blocking signal power [dBm]	Type of interfering signal
LBT	sufficient to maintain the link (see note 2)	2 395 or 2 488,5 (see note 1)	-30	CW
Non-LBT	-30 dBm			
NOTE 1: The highest blocking frequency shall be used for testing the lowest operating hopping frequency, while the lowest blocking frequency shall be used for testing the highest hopping frequency.				
NOTE 2: A typical value which can be used in most cases is -50 dBm/MHz.				

5.11.2. Test Procedure:

See Sub-Clause 5.3.7.1 of ETSI EN 300 328 for the test conditions

See Sub-Clause 5.3.7.2.1 of ETSI EN 300 328 for conducted method.

5.11.3. Test Result:

N/A, this is an equipment using wide band modulation other than FHSS.

6. Other Types of Wide Band Modulation Equipment

6.1. ETSI EN 300 328 SUB-CLAUSE 4.3.2.1 RF Output Power

This requirement applies to all types of equipment using wide band modulations other than FHSS.

6.1.1. Limit:

For adaptive equipment using wide band modulations other than FHSS, the maximum RF output power shall be 20 dBm.

The maximum RF output power for non-adaptive equipment shall be declared by the supplier and shall not exceed 20 dBm. See clause 5.3.1 m). For non-adaptive equipment using wide band modulations other than FHSS, the maximum RF output power shall be equal to or less than the value declared by the supplier.

This limit shall apply for any combination of power level and intended antenna assembly.

6.1.2. Test Procedure:

See Sub-Clause 5.3.2.1 of ETSI EN 300 328 for the test conditions

See Sub-Clause 5.3.2.2.1.1 of ETSI EN 300 328 for conducted method.

6.1.3. Test Result:

Ambient temperature: 25°C

Relative humidity: 60%

Test Date: 2014/09/02

Test Mode: BT LE

Pburst values (value "A" in dBm)

antenna assembly gain "G" in dBi

2.00 dBi

beamforming gain "Y" in dB

0.00 dB

Cable Loss=

20.50 dB

TEST CONDITIONS		TRANSMITTER POWER (dBm)		
		Lowest Frequency (2402MHz)	Middle Frequency (2442MHz)	Highest Frequency (2480MHz)
Temp (-20)°C	Vmin 4.25 V	P 4.70 dBm	P 3.90 dBm	P 3.70 dBm
		A 2.70 dBm	A 1.90 dBm	A 1.70 dBm
		Reading -17.8 dBm	Reading -18.6 dBm	Reading -18.8 dBm
	Vmax 5.75 V	P 4.70 dBm	P 3.90 dBm	P 3.70 dBm
		A 2.70 dBm	A 1.90 dBm	A 1.70 dBm
		Reading -17.8 dBm	Reading -18.6 dBm	Reading -18.8 dBm
Temp (25)°C	Vnom 5 V	P 3.70 dBm	P 3.40 dBm	P 2.70 dBm
		A 1.70 dBm	A 1.40 dBm	A 0.70 dBm
		Reading -18.8 dBm	Reading -19.1 dBm	Reading -19.8 dBm
Temp (55)°C	Vmin 4.25 V	P 1.50 dBm	P 0.30 dBm	P -0.10 dBm
		A -0.50 dBm	A -1.70 dBm	A -2.10 dBm
		Reading -21 dBm	Reading -22.2 dBm	Reading -22.6 dBm
	Vmax 5.75 V	P 1.50 dBm	P 0.30 dBm	P -0.10 dBm
		A -0.50 dBm	A -1.70 dBm	A -2.10 dBm
		Reading -21 dBm	Reading -22.2 dBm	Reading -22.6 dBm
Limit(P)		20dBm		
Measurement uncertainty		+ 0.28dB / - 0.30dB		

6.2. ETSI EN 300 328 SUB-CLAUSE 4.3.2.2 Power Spectral Density

This requirement applies to all types of equipment using wide band modulations other than FHSS.

6.2.1. Limit:

For equipment using wide band modulations other than FHSS, the maximum Power Spectral Density is limited to 10 dBm per MHz.

6.2.2. Test Procedure:

See Sub-Clause 5.3.3.1 of ETSI EN 300 328 for the test conditions

See Sub-Clause 5.3.3.2.1 of ETSI EN 300 328 for conducted method.

6.2.3. Test Result:

Ambient temperature: 25°C

Relative humidity: 60%

Test Date: 2014/09/02

Test Mode: BT LE

measured power density Reading (value "A" in dBm)

antenna assembly gain "G" in dBi

2.00 dBi

beamforming gain "Y" in dB

0.00 dB

Cable Loss=

0.50 dB

Maximum Power Spectrum Density =A+G+Y

TEST CONDITIONS	Power Density Measurement		
	Ch Low dBm/1MHz	Ch Mid dBm/1MHz	Ch High dBm/1MHz
Measured power density Reading	-3.85	-5.04	-5.50
Maximum Power Spectrum Density	-1.35	-2.54	-3.00
Limit	10 dBm/1MHz		
Measurement Uncertainty	+ 1.5dB/ - 1.4dB		

6.3. ETSI EN 300 328 SUB-CLAUSE 4.3.2.3 Duty Cycle, Tx-sequence, Tx-gap

These requirements apply to non-adaptive equipment or to adaptive equipment when operating in a non-adaptive mode.

The equipment is using wide band modulations other than FHSS.

These requirements do not apply for equipment with a maximum declared RF Output power level of less than 10 dBm e.i.r.p. or for equipment when operating in a mode where the RF Output power is less than 10 dBm e.i.r.p.

Medical devices requiring reverse compatibility with other medical devices placed on the market when earlier versions of the present document were harmonised, are allowed to have an operating mode in which they do not have to comply with the requirements for Duty Cycle, Tx-sequence and Tx-gap.

6.3.1. Limit:

The Duty Cycle shall be equal to or less than the maximum value declared by the supplier.

The maximum Tx-sequence Time and the minimum Tx-gap Time shall be according to the formula below:

Maximum Tx-Sequence Time = Minimum Tx-gap Time = M

where M is in the range of 3,5 ms to 10 ms.

6.3.2. Test Procedure:

See Sub-Clause 5.3.2.1 of ETSI EN 300 328 for the test conditions

See Sub-Clause 5.3.2.2.1.2 of ETSI EN 300 328 for conducted method.

6.3.3. Test Result:

N/A, Output power is less than 10 dBm e.i.r.p.

6.4. ETSI EN 300 328 SUB-CLAUSE 4.3.2.4 Medium Utilisation (MU) factor

This requirement does not apply to adaptive equipment unless operating in a non-adaptive mode. In addition, this requirement does not apply for equipment with a maximum declared RF Output power level of less than 10 dBm e.i.r.p. or for equipment when operating in a mode where the RF Output power is less than 10 dBm e.i.r.p.

Medical devices requiring reverse compatibility with other medical devices placed on the market when earlier versions of the present document were harmonised, are allowed to have an operating mode in which they have a Medium Utilisation above the limit defined in clause 4.3.2.4.2.

6.4.1. Limit:

For non-adaptive equipment using wide band modulations other than FHSS, the maximum Medium Utilisation factor shall be 10 %.

The Medium Utilisation (MU) factor is a measure to quantify the amount of resources (Power and Time) used by non-adaptive equipment. The Medium Utilisation factor is defined by the formula:

$MU = (P/100 \text{ mW}) \times DC$, where: MU is Medium Utilisation factor in %.

P is the RF output power as defined in clause 4.3.1.1.1 expressed in mW.

DC is the Duty Cycle as defined in clause 4.3.1.2.1 expressed in %.

6.4.2. Test Procedure:

See Sub-Clause 5.3.2.1 of ETSI EN 300 328 for the test conditions

See Sub-Clause 5.3.2.2.1.3 of ETSI EN 300 328 for conducted method.

6.4.3. Test Result:

N/A, Output power is less than 10 dBm e.i.r.p.

6.5. ETSI EN 300 328 SUB-CLAUSE 4.3.2.5 Adaptivity (Adaptive Equipment Using Modulations Other Than FHSS)

This requirement does not apply to non-adaptive equipment or adaptive equipment operating in a non-adaptive mode providing the equipment complies with the requirements and/or restrictions applicable to non-adaptive equipment.

In addition, this requirement does not apply for equipment with a maximum declared RF Output power level of less than 10 dBm e.i.r.p. or for equipment when operating in a mode where the RF Output power is less than 10 dBm e.i.r.p.

Adaptive equipment using modulations other than FHSS is allowed to operate in a non-adaptive mode providing it complies with the requirements applicable to non-adaptive equipment.

An adaptive equipment using modulations other than FHSS is equipment that uses a mechanism by which it can adapt to its environment by identifying other transmissions present within its Occupied Channel Bandwidth.

Adaptive equipment using modulations other than FHSS shall implement either of the Detect and Avoid mechanisms provided in clauses 4.3.2.5.1 or 4.3.2.5.2.

Adaptive systems are allowed to switch dynamically between different adaptive modes.

6.5.1. Limit:

ETSI EN 300 328 SUB-CLAUSE 4.3.2.5.1 Non-LBT based Detect and Avoid

Channel Occupancy Time shall be less than 40ms.

Idle Period (no transmissions) of minimum 5 % of the Channel Occupancy Time with a minimum of 100 μ s.

ETSI EN 300 328 SUB-CLAUSE 4.3.2.5.2 LBT based Detect and Avoid

The present document defines 2 types of adaptive equipment using wide band modulations other than FHSS and that uses an LBT based Detect and Avoid mechanism: Frame Based Equipment and Load Based Equipment

Adaptive equipment which is capable of operating as either Load Based Equipment or as Frame Based Equipment is allowed to switch dynamically between these types of operation.

ETSI EN 300 328 SUB-CLAUSE 4.3.2.5.2.1 Frame Based Equipment

Clear Channel Assessment (CCA) observation time which shall be not less than 20 μ s.

The Channel Occupancy Time shall be in the range 1 ms to 10 ms followed by an Idle Period of at least 5 % of the Channel Occupancy Time used in the equipment for the current Fixed Frame Period.

ETSI EN 300 328 SUB-CLAUSE 4.3.2.5.2.2.2 Load Based Equipment

Clear Channel Assessment (CCA) observation time which shall be not less than 20 μ s.

If the equipment finds the channel occupied, it shall not transmit on this channel (see note 1). The equipment shall perform an Extended CCA check in which the channel is observed for the duration of a random factor R multiplied by the CCA observation time. R defines the number of clear idle slots resulting in a total Idle Period that needs to be observed before initiation of the transmission. The value of R shall be randomly selected in the range 1...q every time an Extended CCA is required and the value stored in a counter. The value of q is selected by the manufacturer in the range 4...32. This selected value shall be declared by the manufacturer (see clause 5.3.1 d).

The counter is decremented every time a CCA slot is considered to be 'unoccupied'. When the counter reaches zero, the equipment may transmit.

;

Channel Occupancy Time shall be less than $(13/32) \times q$ ms, with q is selected by the manufacturer in the range 4...32, after which the device shall perform the Extended CCA.

ETSI EN 300 328 SUB-CLAUSE 4.3.2.5.3 Short Control Signaling Transmissions

Adaptive equipment may or may not have Short Control Signaling Transmissions

If implemented, Short Control Signaling Transmissions of adaptive equipment using wide band modulations other than FHSS shall have a maximum duty cycle of 10 % within an observation period of 50 ms.

6.5.2. Test Procedure:

See Sub-Clause 5.3.7.1 of ETSI EN 300 328 for the test conditions

See Sub-Clause 5.3.7.2.1.3 of ETSI EN 300 328 for conducted method.

TL= -70dBm/MHz + 20 -Pout e.i.r.p

6.5.3. Test Result:

N/A, Output power is less than 10 dBm e.i.r.p.

6.6. ETSI EN 300 328 SUB-CLAUSE 4.3.2.6 Occupied Channel Bandwidth

This requirement applies to all types of equipment using wide band modulations other than FHSS.

6.6.1. Limit:

The Occupied Channel Bandwidth shall fall completely within the band given in clause 1.
In addition, for non-adaptive systems using wide band modulations other than FHSS and with e.i.r.p greater than 10 dBm, the occupied channel bandwidth shall be less than 20 MHz.

6.6.2. Test Procedure:

See Sub-Clause 5.3.8.1 of ETSI EN 300 328 for the test conditions

See Sub-Clause 5.3.8.2.1 of ETSI EN 300 328 for conducted method.

6.6.3. Test Result:

Ambient temperature: 25°C

Relative humidity: 60%

Test Date: 2014/09/02

Test Mode: BT LE

Occupied Channel Bandwidth		
	Channel Low	Channel High
Occupied Bandwidth (MHz)	1.105	1.082
Lowest/Highest Frequency (MHz)	2401.448	2480.555
Limit (Operating in the band)	2400~2483.5 MHz	2400~2483.5 MHz
Measurement Uncertainty	+/- 120kHz	

6.7. ETSI EN 300 328 SUB-CLAUSE 4.3.2.7 Transmitter Unwanted Emissions in the out-of-band Domain

This requirement applies to all types of equipment using wide band modulations other than FHSS.

6.7.1. Limit:

The transmitter unwanted emissions in the out-of-band domain but outside the allocated band, shall not exceed the values provided by the mask in figure 3.

NOTE: Within the 2 400 MHz to 2 483.5 MHz band, the Out-of-band emissions are fulfilled by compliance with the Occupied Channel Bandwidth requirement in clause 4.3.2.6.

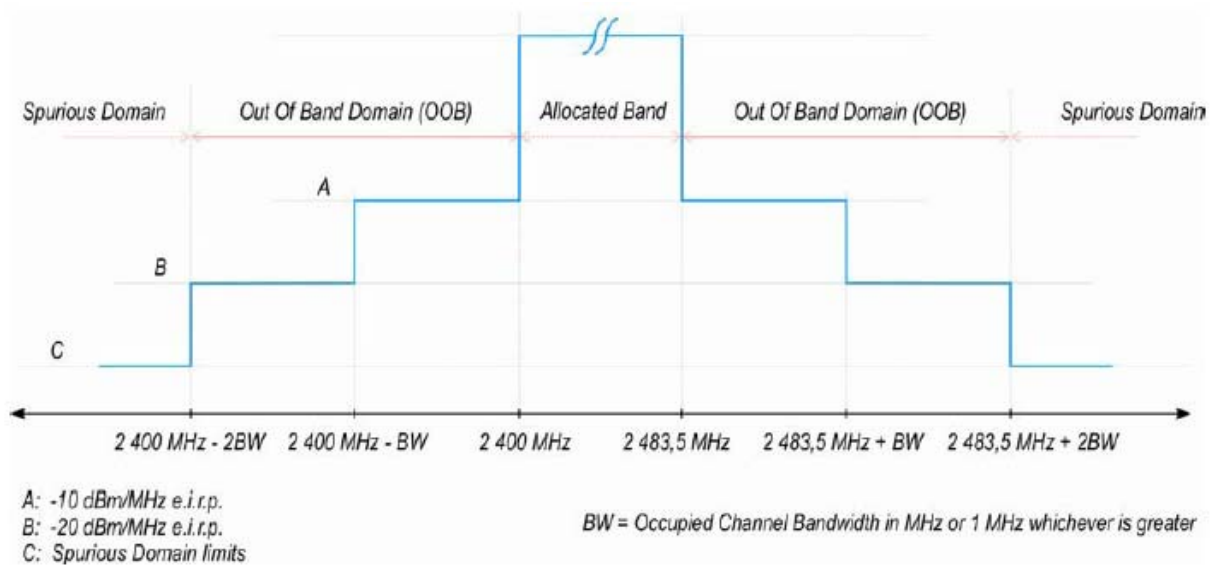

Transmit mask

6.7.2. Test Procedure:

Conducted test method.

See Sub-Clause 5.3.9.1 of ETSI EN 300 328 for the test conditions

See Sub-Clause 5.3.9.2.1 of ETSI EN 300 328 for conducted method.

6.7.3. Test Result:

Ambient temperature: 25°C

Relative humidity: 60%

Test Date: 2014/09/03

Test Mode: BT LE

antenna assembly gain "G" in dBi

2.0 dBi

beamforming gain "Y" in dB

0 dB

Cable Loss=

20.5 dB

Out of Band Domain Emission							
Test condition				2400 ~ 2400-BW	2400-BW ~ 2400-2BW	2483.5 ~ 2483.5+BW	2483.5+BW ~ 2483.5+2BW
Temp (-20)°C	Vmin:	4.25	V	-19.19	-23.31	-31.09	-43.61
	Vmax:	5.75	V	-19.21	-23.66	-31.11	-43.57
Temp (25)°C	Vnom:	5.00	V	-19.37	-23.85	-31.16	-43.66
Temp (55)°C	Vmin:	4.25	V	-22.14	-26.42	-34.37	-46.82
	Vmax:	5.75	V	-22.35	-26.71	-34.11	-46.29
Limit(dBm/MHz)				-10	-20	-10	-20

6.1. ETSI EN 300 328 SUB-CLAUSE 4.3.2.8 Transmitter Unwanted Emissions in the Spurious Domain

This requirement applies to all types of equipment using wide band modulations other than FHSS.

6.1.1. Limit:

The transmitter unwanted emissions in the spurious domain shall not exceed the values given in table

Transmitter limits for Narrowband Spurious emissions

Frequency Range	Maximum power, e.r.p. (≤ 1 GHz) e.i.r.p. (> 1 GHz)	Measurement Bandwidth
30 MHz to 47 MHz	-36 dBm	100 kHz
47 MHz to 74 MHz	-54 dBm	100 kHz
74 MHz to 87,5 MHz	-36 dBm	100 kHz
87,5 MHz to 118 MHz	-54 dBm	100 kHz
118 MHz to 174 MHz	-36 dBm	100 kHz
174 MHz to 230 MHz	-54 dBm	100 kHz
230 MHz to 470 MHz	-36 dBm	100 kHz
470 MHz to 862 MHz	-54 dBm	100 kHz
862 MHz to 1 GHz	-36 dBm	100 kHz
1 GHz to 12,75 GHz	-30 dBm	1 MHz

6.1.2. Test Procedure:

See Sub-Clause 5.3.10.1 of ETSI EN 300 328 for the test conditions

See Sub-Clause 5.3.10.2.1.1 and 5.3.10.2.1.2 of ETSI EN 300 328 for Conducted Pre-Scan test method.

See Sub-Clause 5.3.10.2.2 of ETSI EN 300 328 for final Radiated test method.

6.1.3. Test Result: Radiated

Test Mode: LE mode, TX CH Low

Ambient temperature: 25°C

Relative humidity: 60%

Test Date: 2014/09/04

No	Freq MHz	Reading dBm	Aux dB	Level dBm	Limit dBm	Over Limit dB	Pol V/H
1	106.63	-59.23	0.33	-58.90	-54.00	-4.90	VERTICAL
2	223.03	-63.32	-3.57	-66.89	-54.00	-12.89	VERTICAL
3	295.78	-62.65	-1.28	-63.93	-36.00	-27.93	VERTICAL
4	504.33	-66.90	3.30	-63.60	-54.00	-9.60	VERTICAL
5	664.38	-68.70	6.28	-62.42	-54.00	-8.42	VERTICAL
6	868.08	-72.40	10.32	-62.08	-36.00	-26.08	VERTICAL
7	4804.00	-51.26	11.44	-39.82	-30.00	-9.82	VERTICAL
1	47.46	-65.16	6.14	-59.02	-54.00	-5.02	HORIZONTAL
2	223.03	-61.41	-3.72	-65.13	-54.00	-11.13	HORIZONTAL
3	296.75	-62.86	-0.55	-63.41	-36.00	-27.41	HORIZONTAL
4	455.83	-70.85	2.36	-68.49	-36.00	-32.49	HORIZONTAL
5	664.38	-70.74	6.25	-64.49	-54.00	-10.49	HORIZONTAL
6	815.70	-72.18	9.01	-63.17	-54.00	-9.17	HORIZONTAL
7	4804.00	-50.87	11.85	-39.02	-30.00	-9.02	HORIZONTAL

Measurement uncertainty	30MHz - 80MHz: 5.04dB
	80MHz -1000MHz: 3.76dB
	1GHz - 26GHz: 4.45dB

Remark:

1. The emission behaviors belong to narrowband spurious emission.
2. Remark " --- " means that the emission level is too low to be measured
3. The result basic equation calculation is as follows:
4. $ERP/EIRP (dBm) = SG \text{ Setting}(dBm) + \text{Antenna Gain} (dB/dBi) - \text{Cable loss} (dB)$
5. Measurement Range upto 12.75GHz.

Test Mode: LE mode, TX CH High

Ambient temperature: 25°C

Relative humidity: 60%

Test Date: 2014/09/04

No	Freq MHz	Reading dBm	Aux dB	Level dBm	Limit dBm	Over Limit dB	Pol V/H
1	106.63	-58.68	0.33	-58.35	-54.00	-4.35	VERTICAL
2	223.03	-68.74	-3.57	-72.31	-54.00	-18.31	VERTICAL
3	296.75	-65.76	-1.27	-67.03	-36.00	-31.03	VERTICAL
4	504.33	-67.88	3.30	-64.58	-54.00	-10.58	VERTICAL
5	577.08	-72.09	4.92	-67.17	-54.00	-13.17	VERTICAL
6	794.36	-72.72	8.24	-64.48	-54.00	-10.48	VERTICAL
7	4960.00	-58.51	12.11	-46.40	-30.00	-16.40	VERTICAL
1	47.46	-66.51	6.14	-60.37	-54.00	-6.37	HORIZONTAL
2	110.51	-62.44	-2.11	-64.55	-54.00	-10.55	HORIZONTAL
3	222.06	-60.21	-3.76	-63.97	-54.00	-9.97	HORIZONTAL
4	295.78	-63.14	-0.59	-63.73	-36.00	-27.73	HORIZONTAL
5	455.83	-72.33	2.36	-69.97	-36.00	-33.97	HORIZONTAL
6	815.70	-72.83	9.01	-63.82	-54.00	-9.82	HORIZONTAL
7	4960.00	-54.98	12.47	-42.51	-30.00	-12.51	HORIZONTAL

Measurement uncertainty	30MHz - 80MHz: 5.04dB
	80MHz -1000MHz: 3.76dB
	1GHz - 26GHz: 4.45dB

Remark:

1. The emission behaviors belong to narrowband spurious emission.
2. Remark " --- " means that the emission level is too low to be measured
3. The result basic equation calculation is as follows:
4. ERP/EIRP (dBm) = SG Setting(dBm) + Antenna Gain (dB/dBi) – Cable loss (dB)
5. Measurement Range upto 12.75GHz.

6.2. ETSI EN 300 328 SUB-CLAUSE 4.3.2.9 Receiver Spurious Emissions

This requirement applies to all types of equipment using wide band modulations other than FHSS.

6.2.1. Limit:

The spurious emissions of the receiver shall not exceed the values given in table

Spurious emission limits for receivers

Frequency Range	Maximum power, e.r.p. (≤ 1 GHz) e.i.r.p. (> 1 GHz)	Measurement Bandwidth
30 MHz to 1 GHz	-57 dBm	100 kHz
1 GHz to 12,75 GHz	-47 dBm	1 MHz

6.2.2. Test Procedure:

See Sub-Clause 5.3.11.1 of ETSI EN 300 328 for the test conditions

See Sub-Clause 5.3.11.2.1 and 5.3.11.2.2 of ETSI EN 300 328 for Conducted Pre-Scan test method.

See Sub-Clause 5.3.11.2.2 of ETSI EN 300 328 for final Radiated test method.

6.2.3. Test Result: Radiated

Test Mode: LE mode, RX CH Low

Ambient temperature: 25°C

Relative humidity: 60%

Test Date: 2014/09/04

No	Freq MHz	Reading dBm	Aux dB	Level dBm	Limit dBm	Over Limit dB	Pol V/H
1	106.63	-63.03	0.33	-62.70	-57.00	-5.70	VERTICAL
2	296.75	-66.85	-1.27	-68.12	-57.00	-11.12	VERTICAL
3	491.72	-69.00	3.05	-65.95	-57.00	-8.95	VERTICAL
4	551.86	-72.06	4.40	-67.66	-57.00	-10.66	VERTICAL
5	665.35	-74.78	6.29	-68.49	-57.00	-11.49	VERTICAL
6	793.39	-75.83	8.22	-67.61	-57.00	-10.61	VERTICAL
7	2120.00	-64.19	0.46	-63.73	-47.00	-16.73	VERTICAL
1	106.63	-62.58	-2.31	-64.89	-57.00	-7.89	HORIZONTAL
2	222.06	-61.38	-3.76	-65.14	-57.00	-8.14	HORIZONTAL
3	296.75	-65.33	-0.55	-65.88	-57.00	-8.88	HORIZONTAL
4	455.83	-70.96	2.36	-68.60	-57.00	-11.60	HORIZONTAL
5	594.54	-75.13	5.18	-69.95	-57.00	-12.95	HORIZONTAL
6	813.76	-74.71	8.94	-65.77	-57.00	-8.77	HORIZONTAL
7	3373.00	-68.80	5.09	-63.71	-47.00	-16.71	HORIZONTAL

Measurement uncertainty	30MHz - 80MHz: 5.04dB
	80MHz -1000MHz: 3.76dB
	1GHz - 26GHz: 4.45dB

Remark:

1. The emission behaviors belong to narrowband spurious emission.
2. Remark " --- " means that the emission level is too low to be measured
3. The result basic equation calculation is as follows:
4. ERP/EIRP (dBm) = SG Setting(dBm) + Antenna Gain (dB/dBi) – Cable loss (dB)
5. Measurement Range upto 12.75GHz.

Test Mode: LE mode, RX CH High

Ambient temperature: 25°C

Relative humidity: 60%

Test Date: 2014/09/04

No	Freq MHz	Reading dBm	Aux dB	Level dBm	Limit dBm	Over Limit dB	Pol V/H
1	106.63	-64.43	0.33	-64.10	-57.00	-7.10	VERTICAL
2	295.78	-66.44	-1.28	-67.72	-57.00	-10.72	VERTICAL
3	370.47	-70.76	0.70	-70.06	-57.00	-13.06	VERTICAL
4	504.33	-67.98	3.30	-64.68	-57.00	-7.68	VERTICAL
5	665.35	-72.10	6.29	-65.81	-57.00	-8.81	VERTICAL
6	806.97	-74.29	8.62	-65.67	-57.00	-8.67	VERTICAL
7	1994.00	-59.94	0.04	-59.90	-47.00	-12.90	VERTICAL
1	47.46	-69.69	6.14	-63.55	-57.00	-6.55	HORIZONTAL
2	223.03	-61.26	-3.72	-64.98	-57.00	-7.98	HORIZONTAL
3	369.50	-68.79	0.37	-68.42	-57.00	-11.42	HORIZONTAL
4	455.83	-70.20	2.36	-67.84	-57.00	-10.84	HORIZONTAL
5	593.57	-75.32	5.17	-70.15	-57.00	-13.15	HORIZONTAL
6	816.67	-72.29	9.05	-63.24	-57.00	-6.24	HORIZONTAL
7	3198.00	-68.69	4.32	-64.37	-47.00	-17.37	HORIZONTAL

Measurement uncertainty	30MHz - 80MHz: 5.04dB
	80MHz -1000MHz: 3.76dB
	1GHz - 26GHz: 4.45dB

Remark:

1. The emission behaviors belong to narrowband spurious emission.
2. Remark " --- " means that the emission level is too low to be measured
3. The result basic equation calculation is as follows:
4. ERP/EIRP (dBm) = SG Setting(dBm) + Antenna Gain (dB/dBi) – Cable loss (dB)
5. Measurement Range upto 12.75GHz.

6.3. ETSI EN 300 328 SUB-CLAUSE 4.3.2.10 Receiver Blocking

This requirement does not apply to non-adaptive equipment or adaptive equipment operating in a non-adaptive mode. See also clause 4.3.2.5.

In addition, this requirement does not apply for equipment with a maximum declared RF Output power level of less than 10 dBm e.i.r.p. or for equipment when operating in a mode where the RF Output power is less than 10 dBm e.i.r.p.

6.3.1. Limit:

Adaptive equipment using wide band modulations other than FHSS, shall comply with the requirements defined in clauses 4.3.2.5.1 (non-LBT based DAA) or 4.3.2.5.2 (LBT based DAA) in the presence of a blocking signal with characteristics as provided in table 6.

Table 6: Receiver Blocking parameters

Equipment Type (LBT / non- LBT)	Wanted signal mean power from companion device	Blocking signal frequency [MHz]	Blocking signal power [dBm]	Type of interfering signal
LBT	sufficient to maintain the link (see note 2)	2 395 or 2 488,5 (see note 1)	-30	CW
Non-LBT	-30 dBm			
NOTE 1: The highest blocking frequency shall be used for testing the lowest operating channel, while the lowest blocking frequency shall be used for testing the highest operating channel.				
NOTE 2: A typical value which can be used in most cases is -50 dBm/MHz.				

6.3.2. Test Procedure:

See Sub-Clause 5.3.7.1 of ETSI EN 300 328 for the test conditions

See Sub-Clause 5.3.7.2.1 of ETSI EN 300 328 for conducted method.

6.3.3. Test Result:

N/A. Output power is less than 10 dBm e.i.r.p.

APPENDIX 1

PHOTOGRAPHS OF SET UP

Front of Set up

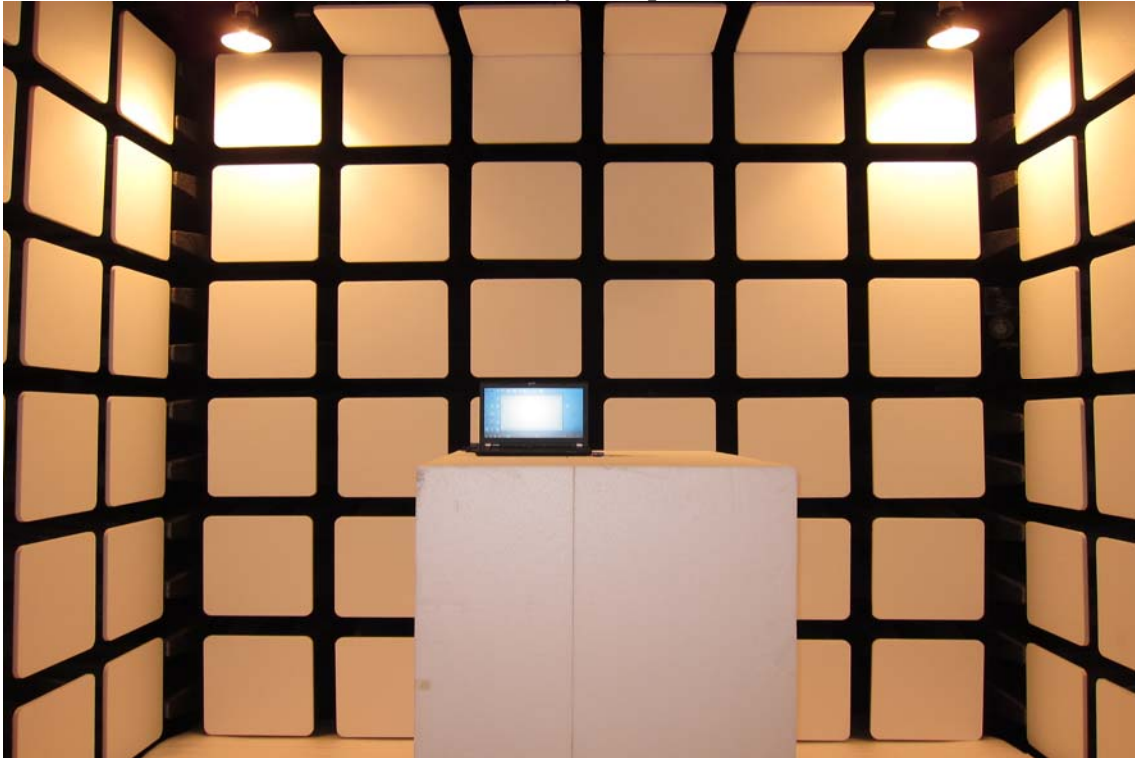

Back of Set up

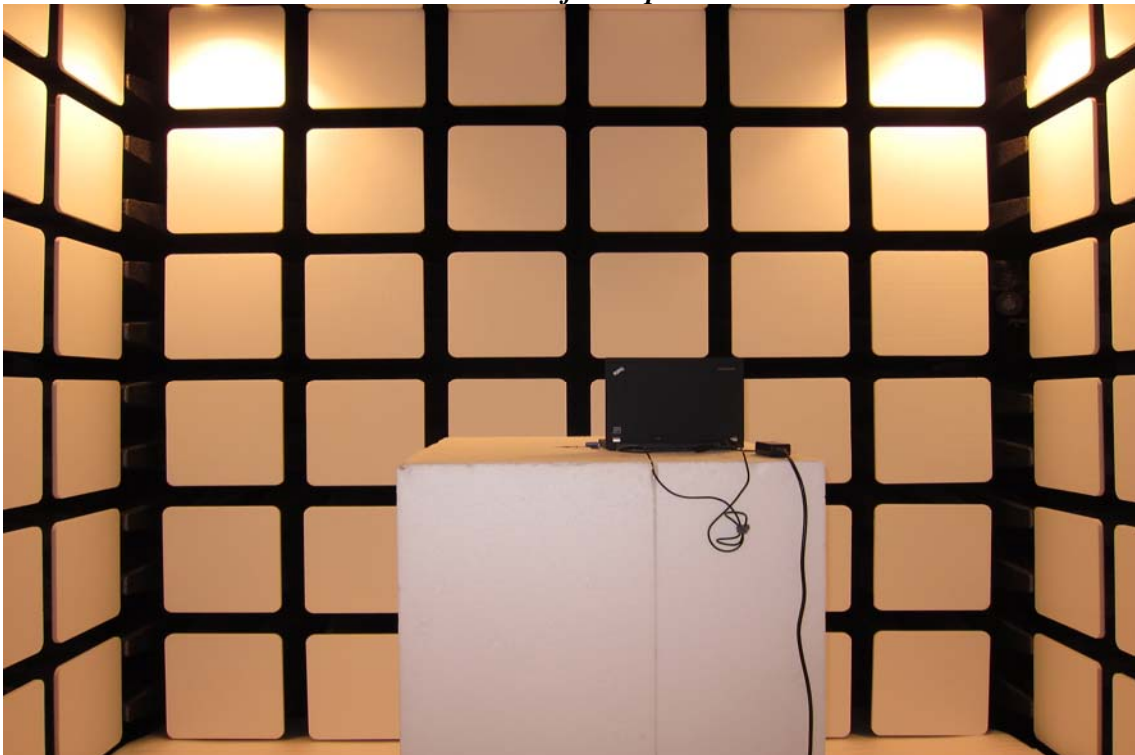



APPENDIX 2

PHOTOGRAPHS OF EUT

EUT 1



EUT 2



EUT 3



EUT 4

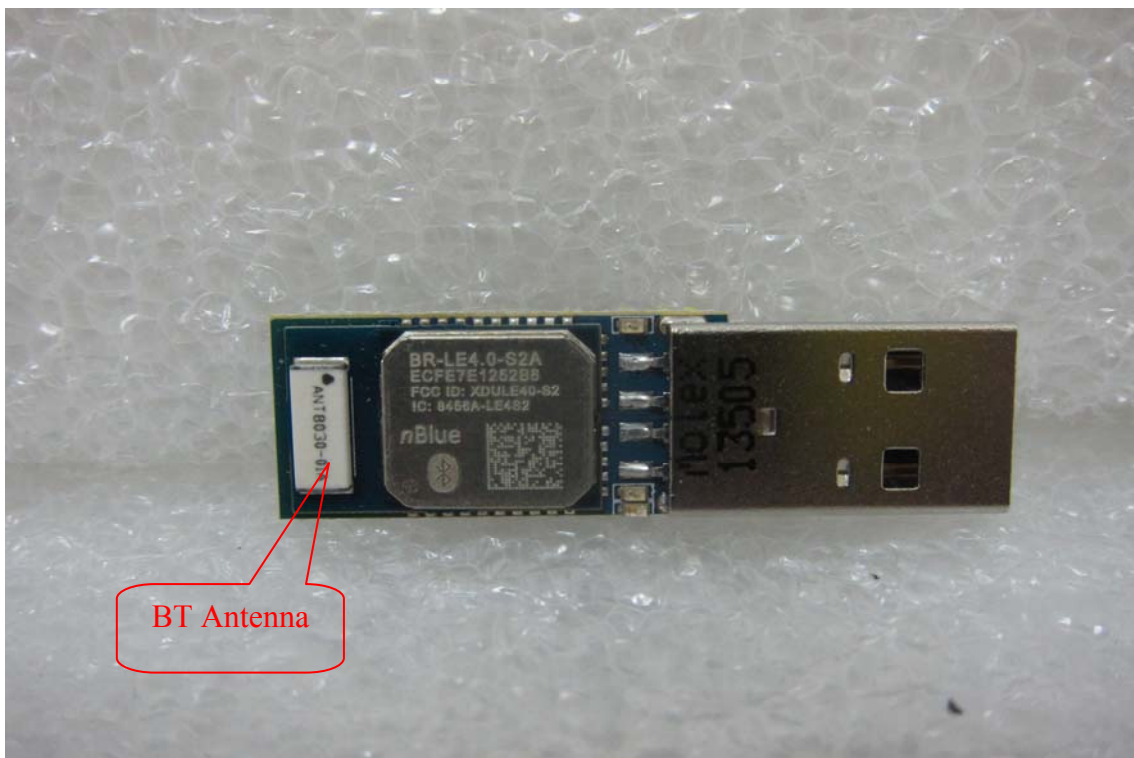

EUT 5



~ End of Report ~